



N I S H I O  
C O N C R E T E  
C O R P O R A T I O N

**西尾コンクリート工業株式会社**

■本社 愛知県西尾市上町東池原1番地1 〒445-0894  
TEL.0563-54-4144(代) FAX.0563-54-4125  
■豊田営業所 愛知県豊田市幸町家下34番地 〒470-1203  
TEL.0565-21-1555(代) FAX.0565-21-1533

**NISHIO**  
CONCRETE  
CORPORATION

L型水路

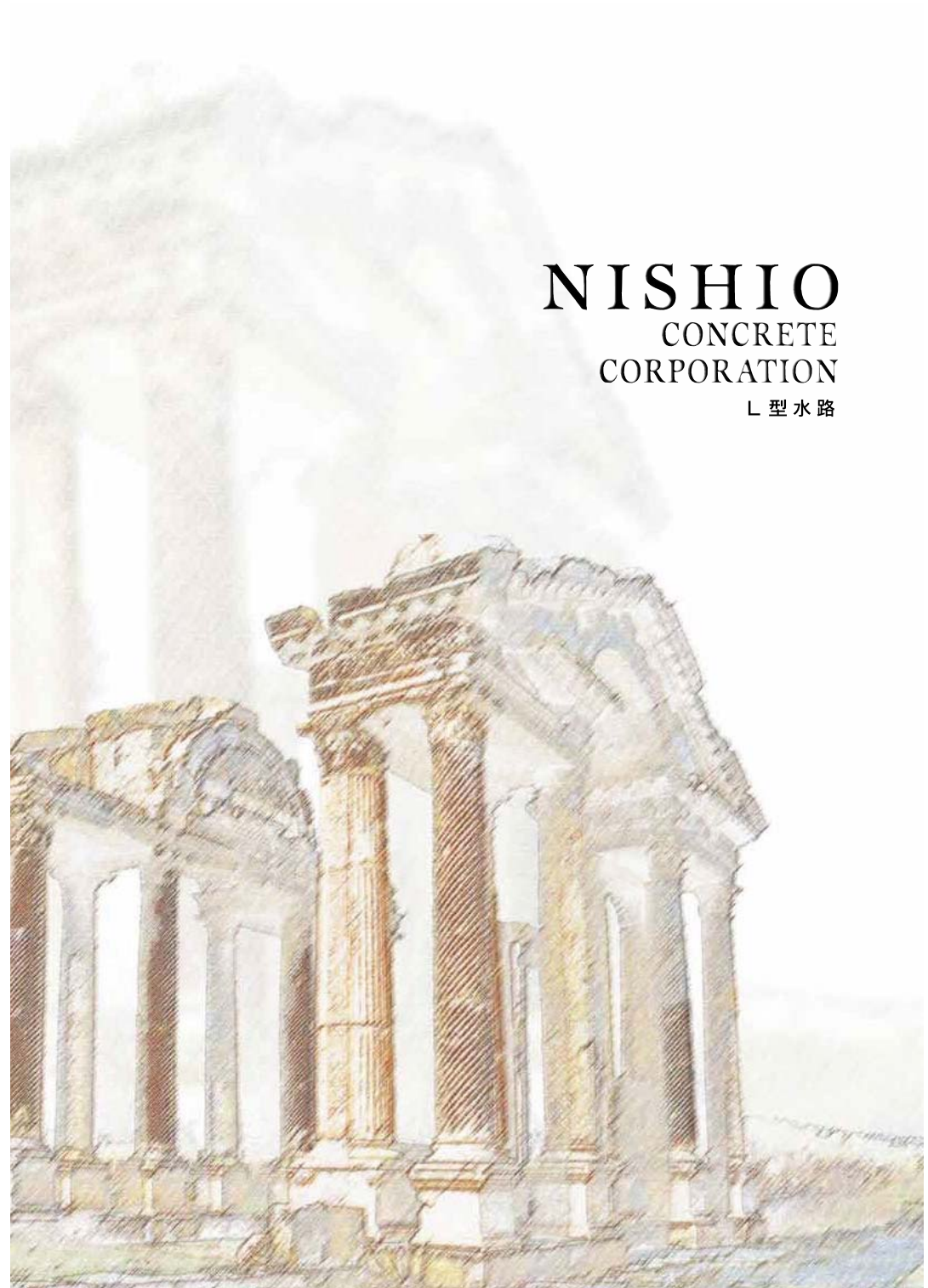

C O N T E N T S

02 …… 施工例

03 …… 形状及び寸法

04 …… 設計条件

05 …… 標準施工例及び布設歩掛り

06 …… 現場打設コンクリート量

07 …… 流速流量表

14 …… 製品吊り上げ状況





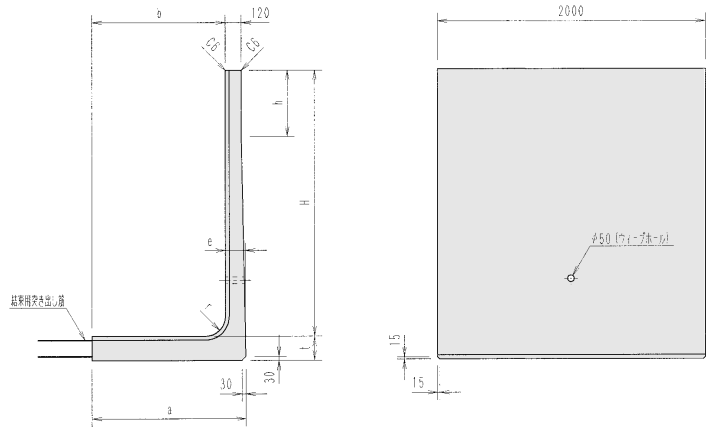

※1. 結束用突き出し筋の突き出し長さは主筋筋の径の30倍以上とする。  
 2. 構造計算書、配筋図等は御要望により提出致します。



呼び名 H	寸法 (mm)						参考質量 (Kg)
	a	b	e	t	h	r	
600	433	300	130	130	100	150	640
700	433	300	130	130	200	150	690
800	533	400	130	130	300	150	810
900	533	400	130	130	400	150	860
1000	633	500	130	130	500	150	980
1100	633	500	130	130	600	150	1050
1200	733	600	130	130	700	150	1170
1300	733	600	130	130	800	150	1230
1400	833	700	130	130	900	150	1350
1500	833	700	130	130	1000	150	1410
1600	954	800	150	180	100	150	1860
1700	954	800	150	180	200	150	1920
1800	1154	1000	150	180	300	150	2150
1900	1154	1000	150	180	400	150	2200
2000	1154	1000	150	180	500	150	2260
2100	1276	1100	170	230	100	180	2860
2200	1276	1100	170	230	200	180	2920
2300	1276	1100	170	230	300	180	2980
2400	1376	1200	170	230	400	180	3140
2500	1376	1200	170	230	500	180	3200

■特長

1. 水路幅が自由に選定できます
2. 法高600から2500まで20種類と豊富な種類
3. 短時間に施工ができ、大巾な工期の短縮が可能です
4. 仕上がりがきれいです
5. 14t、25t荷重を用途に応じて、御使用になれます
6. 品質管理のゆきとどいた、JIS表示許可工場において製作される均一な品質のコンクリート製品です

L型水路は、T-14用及びT-25用の2種類で設計しております。  
 次の条件により、応用計算及び躯体断面計算を行っております。  
 なお、設計条件に変更があれば、その都度検討いたします。

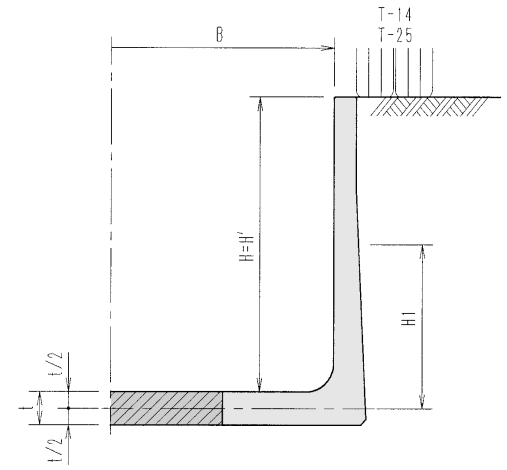

■設計条件

水路断面——水路高 H 水路幅 B  
 載荷量——自動車荷重 T-14 及び T-25  
 側壁から後輪外側までの距離 X'=0m  
 車輪の接地幅 a=0.5m b=0.2m  
 衝撃係数 I=0.3  
 水位——外水位  $H_1 = \frac{H+t}{2}$  内水位  $H + \frac{t}{2}$   
 単位重量——湿潤土  $\gamma_s = 1.8 \text{tf/m}^3$  (18kN/m<sup>3</sup>)  
 水中土  $\gamma_w = 1.0 \text{tf/m}^3$  (10kN/m<sup>3</sup>)  
 コンクリート  $\gamma_c = 2.500 \text{tf/m}^3$  (25kN/m<sup>3</sup>)  
 水  $w_0 = 1.0 \text{tf/m}^3$  (9.8kN/m<sup>3</sup>)  
 土の内部摩擦角—— $\phi = 25^\circ$   
 土圧係数—— $K_a = 0.361$   
 許容応力度——コンクリート  
 ・許容圧縮応力度  
 [製品]  $\sigma_{cs} = 110 \text{kgf/cm}^2$  (1100kg/cm<sup>2</sup>)  
 [現場打]  $\sigma_{cs} = 80.00 \text{kgf/cm}^2$  (800kg/cm<sup>2</sup>)  
 ・せん断応力度  
 [製品]  $\tau_s = 5.000 \text{kgf/cm}^2$  (50kg/cm<sup>2</sup>)  
 [現場打]  $\tau_s = 4.250 \text{kgf/cm}^2$  (42.5kg/cm<sup>2</sup>)  
 ・付着応力度  
 [製品]  $\tau_{cs} = 18.00 \text{kgf/cm}^2$  (180kg/cm<sup>2</sup>)  
 [現場打]  $\tau_{cs} = 15.00 \text{kgf/cm}^2$  (150kg/cm<sup>2</sup>)  
 鉄筋  
 ・許容引張応力度  
 $\sigma_{ts} = 1600 \text{kg/cm}^2$  (157N/mm<sup>2</sup>)  
 ヤング係数比——n=15

■設計計算方法

農林水産省農村振興局  
 土地改良事業標準設計図面集「鉄筋コンクリート二次製品」を採用し、  
 自動車荷重を等分布荷重に換算しております。

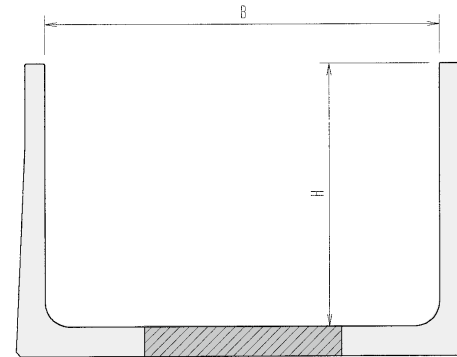
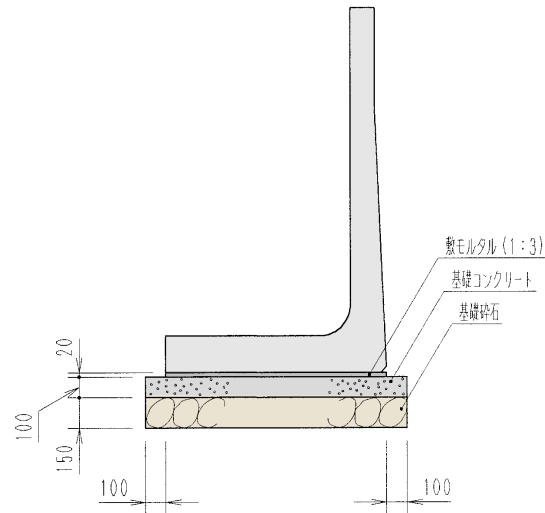

布設歩掛り

呼び名 H (mm)	標準 布設量 (本/日)	世話役 (人/日)	特 殊 作業員 (人/日)	普 通 作業員 (人/日)	接 合 材料費率 (%)	目 地 モルタル量 (m <sup>2</sup> /本)	呼び名 H (mm)	標準 布設量 (本/日)	世話役 (人/日)	特 殊 作業員 (人/日)	普 通 作業員 (人/日)	接 合 材料費率 (%)	目 地 モルタル量 (m <sup>2</sup> /本)								
600	32	1.0	1.0	3.0	1.0	0.00034	1600	26	1.0	1.0	4.0	1.0	0.00099								
700						0.00037	1700						0.00101								
800	0.00044					1800	0.00112														
900	0.00047					1900	0.00115														
1000	0.00053					2000	0.00118														
1100	0.00056			2100		0.00132															
1200	28			1.0		3.5	1.0						1.0	0.00063	2200	24	1.0	1.0	4.5	1.0	0.00135
1300														0.00066	2300						0.00138
1400														0.00073	2400						0.00145
1500														0.00075	2500						0.00147

- ※ 1. 上記の数値は標準的な場合を示します。施工量、連続性、曲線の有無、作業現場の広狭や土質などの現場条件により異なります。
- 2. クレーンは製品重量の3倍以上の能力のあるものを御使用下さい。
- 3. 布設の小運搬を含みます。
- 4. クレーンの運転労務は含みません。
- 5. 掘削、埋戻し、水替えなどは含みません。

現場打設コンクリート量 (水路延長1m当り)

水路寸法 H×B	コンクリート量 (m <sup>3</sup> )	水路寸法 H×B	コンクリート量 (m <sup>3</sup> )	水路寸法 H×B	コンクリート量 (m <sup>3</sup> )	水路寸法 H×B	コンクリート量 (m <sup>3</sup> )
600×2000	0.182	1000×2500	0.195	1400×4500	0.403	2100×3000	0.184
700	2500	1100	3000	1500	5000	2200	3500
	3000		3500		5500	2300	4000
	3500		4000		6000		4500
	4000		4500	1600×3000	0.252		5000
	4500		5000		0.342		5500
	5000		5500		0.432		6000
	5500		6000		0.522		
	6000		6000		0.650		
		1200×3000	0.234		4500	2400×3000	0.138
		1300	3500	0.299	5000	2500	3500
			4000	0.364	5500		4000
			4500	0.429	6000		4500
			5000	0.494		1800×3000	0.180
			5500	0.559		1900	3500
			6000	0.624		2000	4000
							4500
							5000
		1400×3000	0.208		5000		5500
		1500	3500	0.273	5500		6000
			4000	0.338	6000		

流速流量表 1

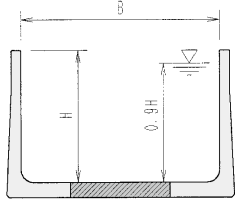

$$V = R^2 \cdot I^2 \cdot \frac{1}{n} \quad Q = A \cdot V$$

マンニング公式による  
 Q : 流量 (m³/sec)  
 V : 流速 (m/sec)  
 R : 径深 (A/P)  
 P : 潤辺 (m)  
 A : 流水断面積 (m²)  
 I : 勾配  
 n : 粗度係数 (0.014)

水路断面	H600×B4000	H600×B5000	H600×B6000	H700×B4000	H700×B5000	H700×B6000	H800×B4000	H800×B5000	H800×B6000
流水断面積 (A)	2,1503	2,6903	3,2303	2,5103	3,1403	3,7703	2,8703	3,5903	4,3103
潤辺 (P)	4,9510	5,9510	6,9510	5,1310	6,1310	7,1310	5,3110	6,3110	7,3110
径深 (R)	0,4343	0,4521	0,4647	0,4892	0,5122	0,5287	0,5404	0,5689	0,5896
勾配	V Q	V Q	V Q	V Q	V Q	V Q	V Q	V Q	V Q
1 : 100	4,0964 8,8085	4,2071 11,3184	4,2857 13,8441	4,4350 11,1332	4,5729 14,3603	4,6707 17,6099	4,7393 13,6032	4,9043 17,6079	5,0221 21,6468
1 : 150	3,3447 7,1921	3,4351 9,2414	3,4993 11,3038	3,6212 9,0903	3,7337 11,7249	3,8136 14,3784	3,8696 11,1069	4,0043 14,3766	4,1006 17,6748
1 : 200	2,8966 6,2286	2,9749 8,0034	3,0305 9,7894	3,1360 7,8723	3,2335 10,1542	3,3027 12,4522	3,3512 9,6189	3,4679 12,4508	3,5512 15,3067
1 : 250	2,5908 5,5710	2,6608 7,1584	2,7105 8,7557	2,8049 7,0411	2,8921 9,0821	2,9540 11,1375	2,9974 8,6034	3,1017 11,1360	3,1763 13,6908
1 : 300	2,3651 5,0857	2,4290 6,5347	2,4744 7,9931	2,5605 6,4276	2,6401 8,2907	2,6966 10,1670	2,7362 7,8537	2,8315 10,1659	2,8995 12,4977
1 : 350	2,1896 4,7083	2,2488 6,0499	2,2908 7,4000	2,3706 5,9509	2,4443 7,6758	2,4966 9,4129	2,5333 7,2713	2,6214 9,4116	2,6844 11,5706
1 : 400	2,0482 4,4042	2,1036 5,6593	2,1429 6,9222	2,2175 5,5666	2,2864 7,1800	2,3354 8,8052	2,3696 6,8015	2,4521 8,8038	2,5111 10,8236
1 : 500	1,8320 3,9393	1,8815 5,0618	1,9166 6,1912	1,9834 4,9789	2,0450 6,4219	2,0888 7,8754	2,1195 6,0836	2,1933 7,8746	2,2460 9,6809
1 : 600	1,6724 3,5962	1,7176 4,6209	1,7496 5,6517	1,8106 4,5451	1,8669 5,8626	1,9068 7,1892	1,9348 5,5535	2,0022 7,1885	2,0503 8,8374
1 : 700	1,5483 3,3293	1,5901 4,2778	1,6198 5,2324	1,6763 4,2080	1,7284 5,4277	1,7654 6,6561	1,7913 5,1416	1,8536 6,6550	1,8982 8,1818
1 : 800	1,4483 3,1143	1,4874 4,0016	1,5152 4,8946	1,5680 3,9362	1,6167 5,0769	1,6513 6,2259	1,6756 4,8095	1,7339 6,2252	1,7756 7,6534
1 : 900	1,3655 2,9362	1,4024 3,7729	1,4286 4,6148	1,4783 3,7110	1,5240 4,7868	1,5569 5,8700	1,5796 4,5345	1,6348 5,8694	1,6740 7,2154
1 : 1000	1,2954 2,7855	1,3304 3,5792	1,3553 4,3780	1,4025 3,5207	1,4461 4,5412	1,4470 5,5687	1,4987 4,3017	1,5509 5,5682	1,5881 6,8452
1 : 1250	1,1586 2,4913	1,1900 3,2015	1,2122 3,9158	1,2544 3,1489	1,2934 4,0617	1,3211 4,9809	1,3405 3,8476	1,3871 4,9801	1,4205 6,1228
1 : 1500	1,0577 2,2744	1,0863 2,9225	1,1066 3,5746	1,1451 2,8745	1,1807 3,7078	1,2060 4,5470	1,2237 3,5124	1,2663 4,5464	1,2967 5,5892
1 : 1750	0,9792 2,1056	1,0057 2,7056	1,0245 3,3094	1,0602 2,8614	1,0931 3,4327	1,1165 4,2095	1,1329 3,2518	1,1723 4,2089	1,2005 5,1745
1 : 2000	0,9160 1,9697	0,9407 2,5308	0,9583 3,0956	0,9917 2,4895	1,0225 3,2110	1,0444 3,9377	1,0597 3,0417	1,0966 3,9371	1,1230 4,8405
1 : 2500	0,8193 1,7617	0,8414 2,2636	0,8571 2,7687	0,8870 2,2266	0,9146 2,8721	0,9341 3,5218	0,9479 2,7208	0,9809 3,5217	1,0044 4,3293
1 : 3000	0,7479 1,6082	0,7681 2,0664	0,7825 2,5277	0,8097 2,0326	0,8349 2,6218	0,8527 3,2149	0,8653 2,4837	0,8954 3,2148	0,9169 3,9521
1 : 3500	0,6924 1,4889	0,7111 1,9131	0,7244 2,3400	0,7496 1,8817	0,7729 2,4271	0,7895 2,9767	0,8011 2,2994	0,8290 2,9764	0,8489 3,6590
1 : 4000	0,6477 1,3927	0,6652 1,7896	0,6776 2,1889	0,7012 1,7602	0,7230 2,2704	0,7385 2,7844	0,7493 2,1507	0,7754 2,7839	0,7941 3,4228

流速流量表 2

水路断面	H900×B4000	H900×B5000	H900×B6000	H1000×B4000	H1000×B5000	H1000×B6000	H1100×B4000	H1100×B5000	H1100×B6000
流水断面積 (A)	3,2303	4,0403	4,8503	3,5903	4,4903	5,3903	3,9503	4,9403	5,9303
潤辺 (P)	5,4910	6,4910	7,4910	5,6710	6,6710	7,6710	5,8510	6,8510	7,8510
径深 (R)	0,5883	0,6224	0,6475	0,6331	0,6731	0,7027	0,6751	0,7211	0,7554
勾配	V Q	V Q	V Q	V Q	V Q	V Q	V Q	V Q	V Q
1 : 100	5,0150 16,2000	5,2071 21,0382	5,3457 25,9282	5,2664 18,9080	5,4864 24,6356	5,6457 30,4320	5,4971 21,7152	5,7436 28,3751	5,9243 35,1329
1 : 150	4,0947 13,2271	4,2516 17,1777	4,3648 21,1706	4,3000 15,4383	4,4797 20,1152	4,6097 24,8477	4,4884 17,7305	4,6896 23,1680	4,8372 28,6860
1 : 200	3,5461 11,4550	3,6479 14,8764	3,7239 18,3341	3,7800 13,3699	3,8795 17,4201	3,9921 21,5186	3,8871 15,3552	4,0613 20,0640	4,1891 24,8426
1 : 250	3,1718 10,2459	3,2933 13,3059	3,3809 16,3984	3,3308 11,9586	3,4699 15,5809	3,5707 19,2471	3,4767 13,7340	3,6326 17,9461	3,7468 22,2196
1 : 300	2,8954 9,3530	3,0063 12,1464	3,0863 14,9695	3,0406 10,9167	3,1676 14,2235	3,2596 17,5702	3,1738 12,5375	3,3161 16,3825	3,4204 20,2840
1 : 350	2,6806 8,6591	2,7833 11,2454	2,8574 13,8592	2,8150 10,1067	2,9326 13,1683	3,0178 16,2668	2,9383 11,6072	3,0701 15,1672	3,1667 17,7795
1 : 400	2,5075 8,1000	2,6036 10,5193	2,6729 12,9647	2,6332 9,4540	2,7432 12,3178	2,8229 15,2163	2,7486 10,8578	2,8718 14,1876	2,9621 17,5661
1 : 500	2,2428 7,2449	2,3287 9,4086	2,3964 11,5956	2,3552 8,4559	2,4536 11,0174	2,5248 13,6094	2,4584 9,7114	2,5686 12,6897	2,6494 15,7117
1 : 600	2,0474 6,6137	2,1258 8,5889	2,1824 10,5853	2,1500 7,7191	2,2398 10,0574	2,3049 12,4241	2,2442 8,8653	2,3448 11,5840	2,4186 14,3430
1 : 700	1,8955 6,1230	1,9681 7,9517	2,0205 9,8000	1,9905 7,1465	2,0737 9,3115	2,1339 11,5024	2,0777 8,2075	2,1709 10,7249	2,2392 13,2791
1 : 800	1,7731 5,7276	1,8410 7,4382	1,8900 9,1671	1,8620 6,6851	1,9397 8,7098	1,9961 10,7596	1,9435 7,6774	2,0307 10,0323	2,0946 12,4216
1 : 900	1,6717 5,4001	1,7357 7,0127	1,7819 8,6427	1,7555 6,3028	1,8288 8,2119	1,8819 10,1440	1,8324 7,2385	1,9145 9,4582	1,9748 11,7112
1 : 1000	1,5859 5,1229	1,6466 6,6528	1,6905 8,1994	1,6654 5,9793	1,7350 7,7907	1,7853 9,6233	1,7383 6,8668	1,8163 8,9731	1,8734 11,1098
1 : 1250	1,4185 4,5822	1,4728 5,9506	1,5120 7,3337	1,4896 5,3481	1,5518 6,9680	1,5968 8,6072	1,5548 6,1419	1,6245 8,0255	1,6756 9,9368
1 : 1500	1,2949 4,1829	1,3445 5,4322	1,3803 6,6949	1,3598 4,8821	1,4166 6,3610	1,4577 8,7854	1,4194 5,6071	1,4830 7,3265	1,5296 9,0710
1 : 1750	1,1989 3,8725	1,2447 5,0290	1,2779 6,1982	1,2589 4,5198	1,3115 5,8890	1,3496 7,2747	1,3141 5,1911	1,3730 6,7830	1,4162 8,3985
1 : 2000	1,1214 3,6225	1,1644 4,7045	1,1953 5,7976	1,1776 4,2279	1,2268 5,5087	1,2624 6,8047	1,2292 4,8557	1,2843 6,3448	1,3247 7,8559
1 : 2500	1,0030 3,2400	1,0414 4,2076	1,0691 5,1855	1,0533 3,7817	1,0973 4,9272	1,1291 6,0862	1,0994 4,3430	1,1487 5,6749	1,1849 7,0268
1 : 3000	0,9156 2,9577	0,9507 3,8411	0,9760 4,7339	0,9615 3,4521	1,0017 4,4979	1,0308 5,5563	1,0036 3,9465	1,0486 5,1804	1,0816 6,4142
1 : 3500	0,8477 2,7393	0,8802 3,5563	0,9036 4,3827	0,8902 3,1961	0,9274 4,1643	0,9543 5,1440	0,9292 3,6706	0,9708 4,7960	1,0014 5,9386
1 : 4000	0,7929 2,5613	0,8233 3,3264	0,8452 4,0995	0,8327 2,9896	0,8675 3,8953	0,8927 4,8119	0,8692 3,4336	0,9081 4,4863	0,9367 5,5549

流速流量表 3

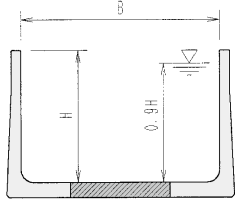

$$V = R^{\frac{2}{3}} \cdot I^{\frac{1}{4}} \cdot \frac{1}{n} \quad Q = A \cdot V$$

マンニング公式による  
 Q : 流量 (m³/sec)  
 V : 流速 (m/sec)  
 R : 径深 (A/P)  
 P : 潤辺 (m)  
 A : 流水断面積 (m²)  
 I : 勾配  
 n : 粗度係数 (0.014)

水路断面	H1200×B4000	H1200×B5000	H1200×B6000	H1300×B4000	H1300×B5000	H1300×B6000	H1400×B4000	H1400×B5000	H1400×B6000
流水断面積 (A)	4.3103	5.3903	6.4703	4.6703	5.8403	7.0103	5.0303	6.2903	7.5503
潤辺 (P)	6.0310	7.0310	8.0310	6.2110	7.2110	8.2110	6.3910	7.3901	8.3910
径深 (R)	0.7147	0.7666	0.8057	0.7519	0.8099	0.8538	0.7871	0.8512	0.8998
勾配	V Q	V Q	V Q	V Q	V Q	V Q	V Q	V Q	V Q
1 : 100	5.7100 24.6118	5.9836 32.2534	6.1843 40.0143	5.9064 27.5847	6.2064 36.2472	6.4286 45.0664	6.0893 30.6310	6.4150 40.3523	6.6571 50.2631
1 : 150	4.6622 20.0955	4.8856 26.3348	5.0494 32.6711	4.8226 22.5230	5.0675 29.5957	5.2489 36.7964	4.9719 25.0101	5.2378 32.9473	5.4355 41.0397
1 : 200	4.0376 17.4033	4.2310 22.8064	4.3730 28.2946	4.1765 19.5055	4.3886 25.6307	4.5457 31.8667	4.3058 21.6595	4.5361 28.5334	4.7073 35.5415
1 : 250	3.6113 15.5658	3.7843 20.3985	3.9113 25.3073	3.7356 17.4464	3.9253 22.9249	4.0658 28.5025	3.8512 19.3727	4.0572 25.5210	4.2103 31.7890
1 : 300	3.2967 14.2098	3.4546 18.6213	3.5705 23.1022	3.4101 15.9262	3.5833 22.9275	3.7115 26.0187	3.5156 17.6845	3.7037 23.2974	3.8435 29.0196
1 : 350	3.0521 13.1555	3.1994 17.2403	3.3056 21.3882	3.1571 14.7446	3.3175 19.3752	3.4362 24.0888	3.2549 16.3731	3.4290 21.5694	3.5584 26.8670
1 : 400	2.8550 12.3059	2.9918 16.1267	3.0921 20.0068	2.9532 13.7923	3.1032 18.1236	3.2143 22.5332	3.0446 15.3153	3.2075 20.1761	3.3286 25.1319
1 : 500	2.5536 11.0068	2.6759 14.4239	2.7657 17.8949	2.6414 12.3361	2.7756 16.2103	2.8749 20.1539	2.7323 13.6985	2.8689 18.0462	2.9772 22.4788
1 : 600	2.3311 10.0477	2.4428 13.1674	2.5247 16.3356	2.4113 11.2615	2.5338 14.7982	2.6245 18.3985	2.4859 12.5048	2.6189 16.4737	2.7178 20.5202
1 : 700	2.1582 9.3025	2.2616 12.1907	2.3374 15.1237	2.2324 10.4260	2.3458 13.7002	2.4298 17.0336	2.3015 11.5772	2.4246 15.2515	2.5162 18.9981
1 : 800	2.0188 8.7016	2.1155 11.4032	2.1865 14.1473	2.0882 9.7525	2.1943 12.8154	2.2728 15.9330	2.1529 10.8297	2.2680 14.2664	2.3537 17.7711
1 : 900	1.9033 8.2038	1.9945 10.7510	2.0614 13.3379	1.9688 9.1949	2.0688 12.0824	2.1429 15.0224	2.0296 10.2105	2.1383 13.4505	2.2190 16.7541
1 : 1000	1.8057 7.7831	1.8922 10.1995	1.9556 12.6533	1.8678 8.7232	1.9626 11.4622	2.0329 14.2512	1.9256 9.6863	2.0286 12.7605	2.1052 15.8949
1 : 1250	1.6150 6.9611	1.6924 9.1225	1.7492 11.3178	1.6706 7.8022	1.7554 10.2521	1.8183 12.7468	1.7223 8.6637	1.8144 11.4131	1.8829 14.2165
1 : 1500	1.4743 6.3547	1.5450 8.3280	1.5968 10.3318	1.5250 7.1222	1.6025 9.3591	1.6599 11.6364	1.5723 7.9091	1.6563 10.4186	1.7189 12.9782
1 : 1750	1.3650 5.8836	1.4303 7.7097	1.4783 9.5650	1.4119 6.5940	1.4836 8.6647	1.5367 10.7727	1.4556 7.3221	1.5335 9.6462	1.5914 12.0155
1 : 2000	1.2768 5.5034	1.3380 7.2122	1.3828 8.9471	1.3207 6.1681	1.3878 8.1052	1.4375 10.0773	1.3616 6.8493	1.4344 9.0228	1.4886 11.2394
1 : 2500	1.1420 4.9224	1.1967 6.4506	1.2369 8.0031	1.1813 5.5170	1.2413 7.2496	1.2857 9.0131	1.2179 6.1264	1.2830 8.0705	1.3314 10.0525
1 : 3000	1.0425 4.4935	1.0924 5.8884	1.1291 7.3056	1.0784 5.0365	1.1331 6.6176	1.1737 8.2280	1.1117 5.5922	1.1712 7.3672	1.2154 9.1766
1 : 3500	0.9652 4.1603	1.0114 5.4517	1.0453 6.7634	0.9984 4.6628	1.0491 6.1271	1.0866 7.6174	1.0293 5.1777	1.0843 6.8206	1.1253 8.4964
1 : 4000	0.9028 3.8913	0.9461 5.0998	0.9778 6.3267	0.9339 4.3616	0.9813 5.7311	1.0164 7.1253	0.9628 4.8432	1.0143 6.3803	1.0526 7.9474

流速流量表 4

水路断面	H1500×B4000	H1500×B5000	H1500×B6000	H1600×B4000	H1600×B5000	H1600×B6000	H1700×B4000	H1700×B5000	H1700×B6000
流水断面積 (A)	5.3903	6.7403	8.0903	5.7503	7.1903	8.6303	6.1103	7.6403	9.1703
潤辺 (P)	6.5710	7.5710	8.5710	6.7510	7.7510	8.7510	6.9310	7.9310	8.9310
径深 (R)	0.8203	0.8903	0.9439	0.8518	0.9277	0.9862	0.8816	0.9633	1.0268
勾配	V Q	V Q	V Q	V Q	V Q	V Q	V Q	V Q	V Q
1 : 100	6.2593 33.7395	6.6100 44.5534	6.8736 55.6095	6.4186 36.9089	6.7943 48.8531	7.0771 61.0775	6.5671 40.1270	6.9671 53.2307	7.2707 66.6745
1 : 150	5.1107 27.5482	5.3970 36.3774	5.6122 45.4044	5.2407 30.1356	5.5475 39.8882	5.7785 49.8702	5.3621 32.7640	5.6886 43.4626	5.9365 54.4395
1 : 200	4.4260 23.8575	4.6740 31.5042	4.8603 39.3213	4.5386 26.0983	4.8043 34.5444	5.0043 43.1886	4.6437 28.3744	4.9265 37.6399	5.1412 47.1463
1 : 250	3.9587 21.3396	4.1805 28.1778	4.3472 35.1702	4.0595 23.3433	4.2971 30.8974	4.4760 38.6292	4.1534 25.3785	4.4064 33.6662	4.5984 42.1687
1 : 300	3.6138 19.4795	3.8163 25.7230	3.9685 32.1064	3.7058 21.3095	3.9227 28.2054	4.0860 35.2634	3.7915 23.1672	4.0225 30.7331	4.1977 38.4942
1 : 350	3.3457 18.0343	3.5332 23.8148	3.6741 29.7246	3.4309 19.7287	3.6317 26.1130	3.7829 32.6476	3.5103 21.4490	3.7241 28.4532	3.8864 35.6395
1 : 400	3.1296 16.8695	3.3050 22.2767	3.4368 27.8047	3.2093 18.4544	3.3971 24.4262	3.5386 30.5392	3.2836 20.0638	3.4836 26.6157	3.6354 33.3377
1 : 500	2.7992 15.0885	2.9561 19.9250	3.0740 24.8696	2.8502 16.5062	3.0385 21.8477	3.1650 27.3149	2.9369 17.9465	3.1158 23.8056	3.2516 29.8181
1 : 600	2.5553 13.7738	2.6985 18.1887	2.8061 22.7022	2.6204 15.0681	2.7738 19.9445	2.8892 24.9347	2.6810 16.3817	2.8443 21.7313	2.9683 27.2202
1 : 700	2.3658 12.7524	2.4983 16.8393	2.5980 21.0186	2.4260 13.9502	2.5680 18.4647	2.6749 23.0852	2.4821 15.1664	2.6333 20.1192	2.7481 25.2009
1 : 800	2.2130 11.9287	2.3370 15.7521	2.4302 19.6610	2.2693 13.0492	2.4021 17.2718	2.5021 21.5939	2.3218 14.1869	2.4633 18.8204	2.5706 23.5732
1 : 900	2.0864 11.2463	2.2033 14.8509	2.2912 18.5365	2.1395 12.3028	2.2648 16.2846	2.3590 20.3589	2.1890 13.3754	2.3224 17.7438	2.4236 22.2251
1 : 1000	1.9794 10.6696	2.0903 14.0892	2.1736 17.5851	2.0297 11.6714	2.1485 15.4484	2.2380 19.3146	2.0767 12.6893	2.2032 16.8331	2.2992 21.0844
1 : 1250	1.7704 9.5430	1.8696 12.6017	1.9441 15.7284	1.8154 10.4391	1.9217 13.8176	2.0017 17.2753	1.8575 11.3499	1.9706 15.0560	2.0565 18.8587
1 : 1500	1.6161 8.7113	1.7067 11.5037	1.7748 14.3587	1.6573 9.5300	1.7543 12.6139	1.8273 15.7701	1.6965 10.3606	1.7989 13.7441	1.8773 17.2154
1 : 1750	1.4963 8.0655	1.5801 10.6503	1.6431 13.2932	1.5343 8.9227	1.6241 11.8778	1.6918 14.6007	1.5696 9.5919	1.6655 12.7249	1.7390 15.9380
1 : 2000	1.3996 7.5443	1.4780 9.9622	1.5370 12.4348	1.4352 8.2528	1.5192 10.9235	1.5825 13.6574	1.4685 8.9730	1.5579 11.9028	1.6258 14.9091
1 : 2500	1.2519 6.7481	1.3220 8.9107	1.3747 11.1217	1.2837 7.3817	1.3589 9.7709	1.4154 12.2153	1.3134 8.0253	1.3934 10.6460	1.4541 13.3345
1 : 3000	1.1428 6.1600	1.2068 8.1342	1.2549 10.1525	1.1719 6.7388	1.2405 8.9196	1.2921 11.5112	1.1990 7.3262	1.2720 9.7185	1.3274 12.1727
1 : 3500	1.0584 5.7029	1.1173 7.5309	1.1618 9.3993	1.0849 6.2385	1.1484 8.2573	1.1962 10.3236	1.1100 6.7824	1.1777 8.9980	1.2290 11.2703
1 : 4000	0.9857 5.3348	1.0451 7.0443	1.0868 8.7925	1.0149 5.8360	1.0743 7.7245	1.1190 9.6573	1.0384 6.3449	1.1016 8.4166	1.1496 10.5422

流速流量表 5

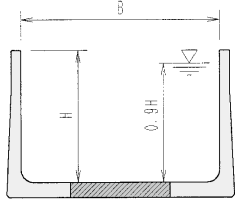

$$V=R^2 \cdot I^2 \cdot \frac{1}{n} \quad Q=A \cdot V$$

- マンニング公式による  
 Q : 流量 (m³/sec)  
 V : 流速 (m/sec)  
 R : 径深 (A/P)  
 P : 測辺 (m)  
 A : 流水断面積 (m²)  
 I : 勾配  
 n : 粗度係数 (0.014)

水路断面	H1800×B4000	H1800×B5000	H1800×B6000	H1900×B4000	H1900×B5000	H1900×B6000	H2000×B4000	H2000×B5000
流水断面積 (A)	6.4703	8.0903	9.7103	6.8303	8.5403	10.2503	7.1903	8.9903
測 辺 (P)	7.1110	8.1110	9.1110	7.2910	8.2910	9.2910	7.4710	8.4710
径 深 (R)	0.9099	0.9974	1.0658	0.9368	1.0301	1.1033	0.9624	1.0613
勾 配	V Q	V Q	V Q	V Q	V Q	V Q	V Q	V Q
1 : 100	6.7071 43.3969	7.1307 57.6895	7.4529 72.3699	6.8386 46.7097	7.2850 62.2161	7.6264 78.1729	6.9629 50.0653	7.4321 66.8168
1 : 150	5.4764 35.4340	5.8222 47.1033	6.0852 59.0891	5.5837 38.1383	5.9482 50.7994	6.2270 63.8286	5.6852 40.8783	6.0633 54.5558
1 : 200	4.7427 30.6867	5.0422 40.7929	5.2700 51.1733	4.8356 33.0286	5.1513 43.9936	5.3927 55.2768	4.9235 35.4014	5.2553 47.2467
1 : 250	4.2420 27.4470	4.5099 36.4864	4.7136 45.7705	4.3251 29.5417	4.6074 39.3486	4.8234 49.4413	4.4037 31.6639	4.7005 42.2589
1 : 300	3.8724 25.0556	4.1169 33.3070	4.3209 41.7824	3.9482 26.9674	4.2060 35.9205	4.4031 45.1331	4.0200 28.9050	4.2909 38.5765
1 : 350	3.5851 23.1967	3.8115 30.8362	3.9837 38.6829	3.6554 24.9675	3.8940 33.2559	4.0765 41.7853	3.7218 28.7609	3.9726 35.7149
1 : 400	3.3536 21.6988	3.5654 28.8452	3.7264 36.1845	3.4193 23.3548	3.6425 31.1080	3.8132 39.0864	3.4814 25.0323	3.7161 33.4089
1 : 500	2.9955 19.4077	3.1890 25.8000	3.3330 32.3644	3.0583 20.8891	3.2580 27.8243	3.4106 34.9597	3.1139 22.3899	3.2688 29.8820
1 : 600	2.7382 17.7170	2.9111 23.5517	3.0426 29.5446	2.7918 19.0688	2.9741 25.3997	3.1135 31.9143	2.8426 20.4391	3.0342 27.2784
1 : 700	2.5351 16.4029	2.6952 21.8050	2.8169 27.3529	2.5847 17.6543	2.7535 23.5157	2.8825 29.5465	2.6317 18.9227	2.8091 25.2547
1 : 800	2.3713 15.3430	2.5211 20.5965	2.6350 25.5866	2.4178 16.5143	2.5756 21.9964	2.6963 27.6379	2.4617 17.7004	2.6277 23.6238
1 : 900	2.2357 14.4656	2.3769 19.2298	2.4843 24.1233	2.2795 15.5697	2.4283 20.7384	2.5421 26.0573	2.3210 16.6887	2.4774 22.2726
1 : 1000	2.1210 13.7235	2.2549 18.2428	2.3568 22.8852	2.1625 14.7705	2.3037 19.6743	2.4117 24.7206	2.2018 15.8316	2.3503 21.1299
1 : 1250	1.8971 12.2748	2.0169 16.3173	2.1080 20.4693	1.9342 13.2112	2.0605 17.5973	2.1571 22.1109	1.9694 14.1606	2.1021 18.8985
1 : 1500	1.7318 11.2053	1.8411 14.8951	1.9243 18.6855	1.7657 12.0603	1.8810 16.0643	1.9691 20.1839	1.7978 12.9267	1.9190 17.2524
1 : 1750	1.6033 10.3738	1.7046 13.7907	1.7816 17.2999	1.6347 11.1655	1.7415 14.8729	1.8231 16.6873	1.6644 11.9675	1.7766 15.9722
1 : 2000	1.4998 9.7042	1.5945 12.9000	1.6665 16.1822	1.5292 10.4449	1.6290 13.9121	1.7053 17.4798	1.5569 11.1946	1.6619 14.9410
1 : 2500	1.3414 8.6793	1.4261 11.5376	1.4906 14.4742	1.3677 9.3418	1.4570 12.4432	1.5253 15.6348	1.3926 10.0132	1.4864 13.3632
1 : 3000	1.2245 7.9229	1.3019 10.5328	1.3607 13.2128	1.2485 8.5276	1.3300 11.3586	1.3924 14.2725	1.2712 9.1403	1.3569 12.1989
1 : 3500	1.1337 7.3354	1.2053 9.7512	1.2598 12.2330	1.1559 7.8951	1.2314 10.5165	1.2891 13.2137	1.1769 8.4623	1.2563 11.2945
1 : 4000	1.0605 6.8618	1.1275 9.1218	1.1784 11.4426	1.0813 7.3856	1.1519 9.8376	1.2058 12.3598	1.1009 7.9158	1.1751 10.5645

流速流量表 6

水路断面	H2000×B6000	H2100×B4000	H2100×B5000	H2100×B6000	H2200×B4000	H2200×B5000	H2200×B6000	H2300×B4000
流水断面積 (A)	10.7903	7.5461	9.4361	11.3261	7.9061	9.8861	11.8661	8.2661
測 辺 (P)	9.4710	7.6252	8.6252	9.6252	7.8052	8.8052	9.8052	7.9852
径 深 (R)	1.1393	0.9896	1.0940	1.1767	1.0129	1.1228	1.2102	1.0352
勾 配	V Q	V Q	V Q	V Q	V Q	V Q	V Q	V Q
1 : 100	7.7914 84.0715	7.0936 53.5290	7.5836 71.5596	7.9614 90.1716	7.2043 56.9579	7.7157 76.2782	8.1114 96.2507	7.3093 60.4194
1 : 150	6.3617 68.6447	5.7919 43.7063	6.1920 58.4283	6.5005 73.6253	5.8823 46.5061	6.2999 62.2814	6.6230 78.5892	5.9680 49.3321
1 : 200	5.5094 59.4481	5.0159 37.8505	5.3624 50.6001	5.6296 63.7614	5.0942 40.2753	5.4588 53.9366	5.7356 68.0592	5.1684 42.7225
1 : 250	4.9277 34.1714	4.4864 33.8548	4.7963 45.2584	5.0352 57.0292	4.5564 36.0234	4.8798 48.2422	5.1301 60.8743	4.6228 38.2125
1 : 300	4.4984 48.5391	4.0955 30.9051	4.3784 41.3150	4.5965 52.0604	4.1594 32.8846	4.4547 44.0396	4.6831 55.5701	4.2200 34.8829
1 : 350	4.1647 44.9384	3.7917 28.6125	4.0536 38.2502	4.2556 48.1994	3.8509 30.4456	4.1242 47.7723	4.3357 51.4478	3.9070 32.2957
1 : 400	3.8957 42.0358	3.5468 26.7645	3.7918 35.7798	3.9807 45.0858	3.6021 28.4786	3.8579 38.1396	4.0557 48.1253	3.6546 30.2093
1 : 500	3.4844 37.5977	3.1723 23.9385	3.2025 32.0025	3.4606 40.3266	3.2219 25.4727	3.4506 34.1130	3.6219 43.0443	3.2688 27.0202
1 : 600	3.1808 34.3218	2.8959 21.8528	3.0960 29.2142	3.2502 36.8121	2.9411 23.2526	3.1499 31.1402	3.3115 39.2946	2.9840 24.6660
1 : 700	2.9449 31.7764	2.6811 20.2318	2.8663 27.0467	3.0091 34.0814	2.7230 21.5283	2.9163 28.8308	3.0658 36.3791	2.7626 22.8359
1 : 800	2.7547 29.7240	2.5080 18.9256	2.6812 25.3001	2.8148 31.8807	2.5471 20.1376	2.7279 26.9683	2.8678 34.0296	2.5842 21.3613
1 : 900	2.5971 28.0235	2.3645 17.8428	2.5279 23.8535	2.6538 30.0572	2.4014 18.9857	2.5719 25.4261	2.7038 32.0836	2.4364 20.1395
1 : 1000	2.4635 26.5862	2.2432 16.9274	2.3981 22.6287	2.5176 28.5146	2.2782 18.0117	2.4399 24.1211	2.5651 30.4377	2.3114 19.1063
1 : 1250	2.2037 23.7786	2.0064 15.1405	2.1450 20.2404	2.2518 25.5041	2.0377 16.1103	2.1823 21.5744	2.2943 27.2244	2.0674 17.0893
1 : 1500	2.0117 20.1708	1.8316 13.8214	1.9581 18.4768	2.0556 23.2819	1.8601 14.7061	1.9922 19.6951	2.0944 24.8524	1.8873 15.6006
1 : 1750	1.8625 20.0969	1.6957 12.7959	1.8128 17.1058	1.9031 21.5847	1.7222 13.6159	1.8444 18.2339	1.9390 23.0084	1.7473 14.4434
1 : 2000	1.7422 18.7989	1.5862 11.9696	1.6957 16.0008	1.7802 20.1627	1.6109 12.7359	1.7253 17.0565	1.8138 21.5227	1.6344 13.5101
1 : 2500	1.5583 16.8145	1.4187 10.7057	1.4187 14.3117	1.5167 18.0345	1.4409 11.3918	1.5233 15.2552	1.6223 19.2504	1.4619 12.0842
1 : 3000	1.4225 15.3492	1.2951 9.7730	1.3846 13.0652	1.4535 16.4625	1.3153 10.3989	1.4087 13.9265	1.4809 17.5725	1.3345 11.0311
1 : 3500	1.3170 14.2108	1.1990 9.0478	1.2818 12.0952	1.3457 15.2415	1.2177 9.6273	1.3042 12.8935	1.3711 16.2696	1.2355 10.2128
1 : 4000	1.2319 13.2926	1.1216 8.4637	1.1991 11.3148	1.2588 14.2573	1.1391 9.0058	1.2200 12.0610	1.2825 15.2183	1.1557 9.5531



# 流速流量表 7

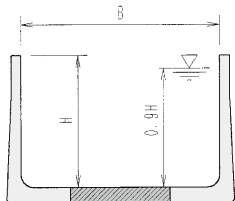

$$V = R^2 \cdot I^2 \cdot \frac{1}{n} \quad Q = A \cdot V$$

マンニング公式による  
 Q：流量 (m³/sec)  
 V：流速 (m/sec)  
 R：径深 (A/P)  
 P：溝辺 (m)  
 A：流水断面積 (m²)  
 I：勾配  
 n：粗度係数 (0.014)

水路断面	H2300×B5000	H2300×B6000	H2400×B4000	H2400×B5000	H2400×B6000	H2500×B4000	H2500×B5000	H2500×B6000
流水断面積 (A)	10.3361	12.4061	8.6261	10.7861	12.9461	8.9861	11.2361	13.4861
溝辺 (P)	8.9852	9.9852	8.1652	9.1652	10.1652	8.3452	9.3452	10.3452
径深 (R)	1.1503	1.2424	1.0564	1.1769	1.2736	1.0768	1.2023	1.3036
勾配	V Q	V Q	V Q	V Q	V Q	V Q	V Q	V Q
1 : 100	7.8421 81.0567	8.2550 102.4124	7.4093 63.9134	7.9621 85.8800	8.3921 108.6450	7.5043 67.4344	8.0764 90.7472	8.5236 114.9501
1 : 150	6.4031 66.1831	6.7402 83.6196	6.0497 52.1853	6.5011 70.1215	6.8522 88.7093	6.1272 55.0596	6.5944 74.0953	6.9595 93.8565
1 : 200	5.5452 57.3157	5.8372 72.4169	5.2392 45.1939	5.6301 60.7268	5.9341 76.8235	5.3063 47.6829	5.7109 64.1682	6.0271 81.2821
1 : 250	4.9598 51.2650	5.2209 64.7710	4.6860 40.4219	5.0357 54.3156	5.3077 68.7140	4.7461 42.6489	5.1080 57.3940	5.3908 72.7009
1 : 300	4.5277 46.7988	4.7660 59.1275	4.2778 36.9007	4.5969 49.5826	4.8452 62.7264	4.3326 38.9332	4.6629 52.3928	4.9211 66.3664
1 : 350	4.1918 43.3269	4.4125 54.7419	3.9604 34.1628	4.2559 45.9046	4.4858 58.0736	4.0112 36.0450	4.3170 48.5062	4.5560 61.4427
1 : 400	3.9211 40.5289	4.1275 51.2062	3.7046 31.9563	3.9811 42.9405	4.1961 54.3231	3.7521 33.7167	4.0382 45.3736	4.2618 57.4751
1 : 500	3.5071 36.2497	3.6917 45.7996	3.3135 28.5826	3.5608 38.4071	3.7531 48.5880	3.3560 30.1574	3.6119 40.5837	3.8119 54.4077
1 : 600	3.2015 33.0910	3.3701 41.8098	3.0248 26.0922	3.2505 35.0602	3.4261 44.3546	3.0636 27.5298	3.2972 37.0477	3.4797 46.9276
1 : 700	2.9641 30.6372	3.1201 38.7083	2.8004 24.1565	3.0094 32.4597	3.1719 41.0637	2.8346 25.4882	3.0526 34.2993	3.2216 43.4468
1 : 800	2.7726 28.6579	2.9186 36.2084	2.6196 22.5969	2.8150 30.3629	2.9671 38.4124	2.6532 23.8419	2.8554 32.0836	3.0135 40.6404
1 : 900	2.6140 27.0186	2.7517 34.1379	2.4698 21.3047	2.6540 28.6263	2.7974 36.2154	2.5014 22.4478	2.6921 30.2487	2.8412 38.3167
1 : 1000	2.4799 25.6325	2.6105 32.3861	2.3430 20.2110	2.5179 27.1583	2.6538 34.3564	2.3731 21.3249	2.5540 28.6970	2.6954 36.3504
1 : 1250	2.2181 22.9265	2.3349 28.9670	2.0957 18.0777	2.2520 24.2903	2.3737 30.7302	2.1225 19.0730	2.2844 25.6677	2.4108 32.5123
1 : 1500	2.0248 20.9285	2.1314 26.4424	1.9131 16.5026	2.0558 22.1741	2.1668 28.0516	1.9376 17.4115	2.0853 24.306	2.2008 29.6802
1 : 1750	1.8746 19.3761	1.9733 24.4610	1.7712 15.2785	1.9033 20.5292	2.0061 25.9712	1.7939 16.1202	1.9306 21.6924	2.0375 27.4779
1 : 2000	1.7536 18.1254	1.8459 22.9004	1.6568 14.2917	1.7804 19.2036	1.8765 24.2934	1.6780 15.0787	1.8059 20.2913	1.9059 25.7032
1 : 2500	1.5684 16.2111	1.6510 20.4825	1.4819 12.7830	1.5924 17.1758	1.6784 21.7287	1.5009 13.4872	1.6153 18.1497	1.7047 22.9898
1 : 3000	1.4318 14.7992	1.5071 18.6972	1.3527 11.6685	1.4537 15.6798	1.5322 19.8360	1.3701 12.3119	1.4745 16.5675	1.5562 20.9871
1 : 3500	1.3256 13.7015	1.3953 17.3102	1.2524 10.8033	1.3458 14.5159	1.4185 18.3640	1.2684 11.3980	1.3652 15.3395	1.4407 19.4294
1 : 4000	1.2400 12.8168	1.3052 16.1924	1.1715 10.1055	1.2589 13.5786	1.3269 17.1782	1.1865 10.6620	1.2770 14.3485	1.3477 18.1752



## ユニバーサルカップラー取扱上の注意

アンカーとユニバーサルカップラーの取付は  
 施工時にもっとも重要な作業です。注意して取扱ってください。

### ■ 取付け

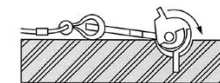

### ■ 取外し

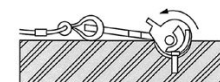

### ■ 垂直方向に吊る場合の作業状況

[良い例]

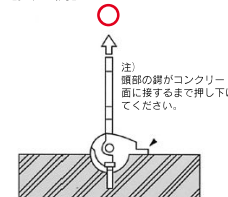

[悪い例]

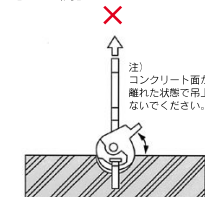

簡単につかえる  
 ものですが、  
 安全には  
 気をつけて下さい

