

大型化長尺化プレキャストコンクリート製品

【ベース付歩車道境界ブロック】

[標準・水抜き]

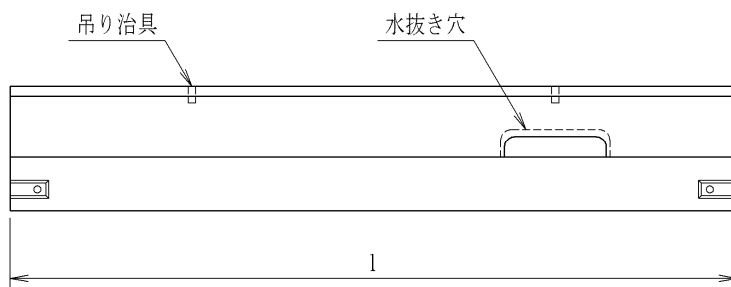
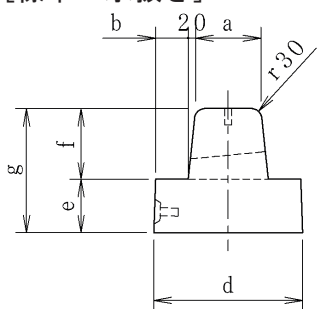

[切り下げ]

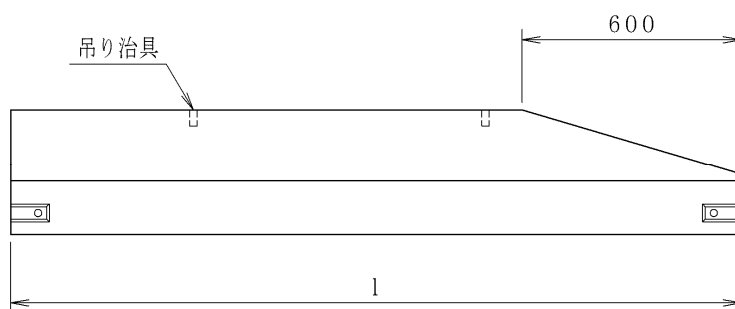
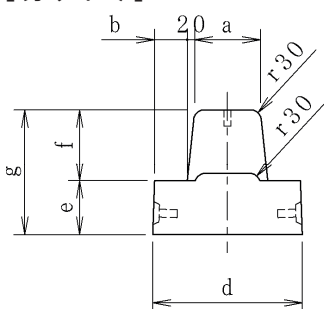

[乗り入れ]

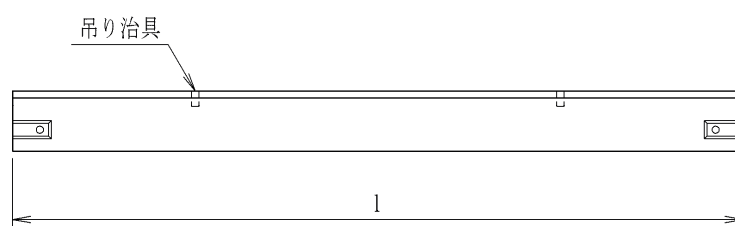
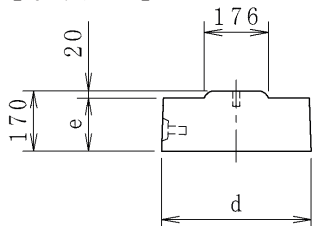

呼び	寸法 (mm)							参考重量 (kg)
	a	b	d	e	f	g	l	
B	180	90	410	150	200	350	2000	451

【ベース付地先境界ブロック】

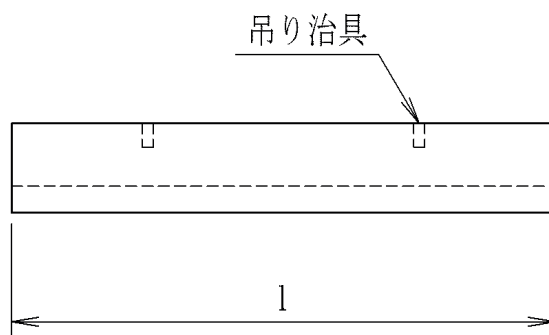
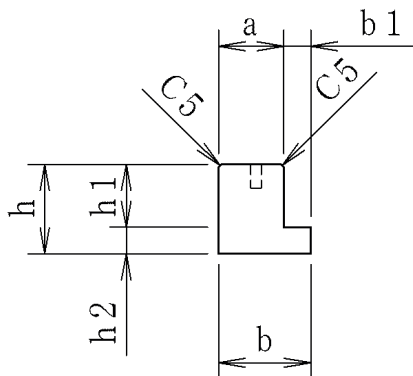

呼び名	寸法 (mm)							参考重量 (kg)
	a	b	b1	h	h1	h2	l	
A	120	170	50	170	120	50	1000	53

【ベース付両面ブロック】

[標準]

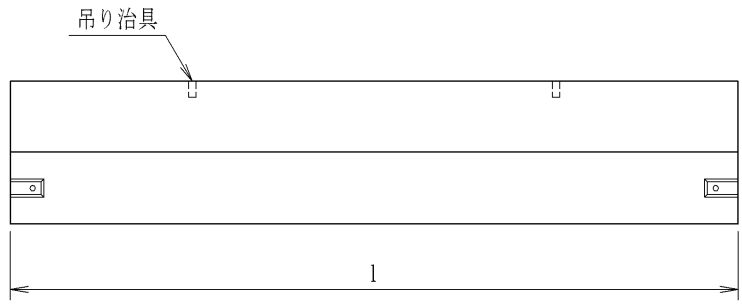
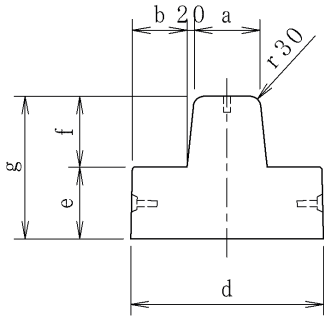

[水抜き]

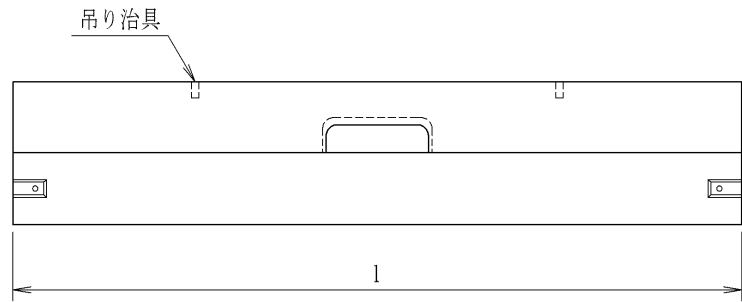
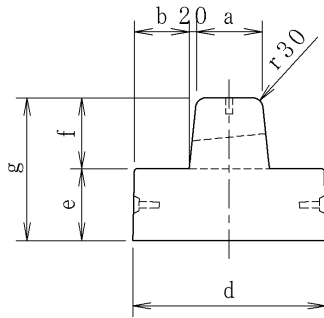

[切り下げ]

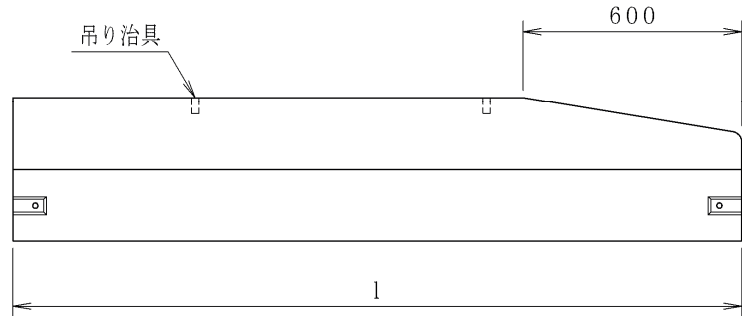
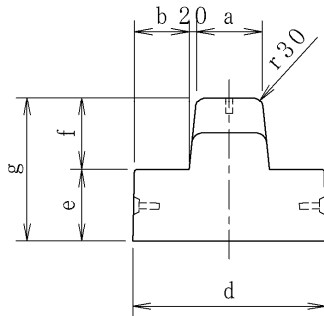

呼び名	寸法 (mm)								参考重量 (kg)
	a	b	c	d	e	f	g	L	
B	180	150	520	530	200	200	400	2000	667

【ベース付片面歩車道境界ブロック】

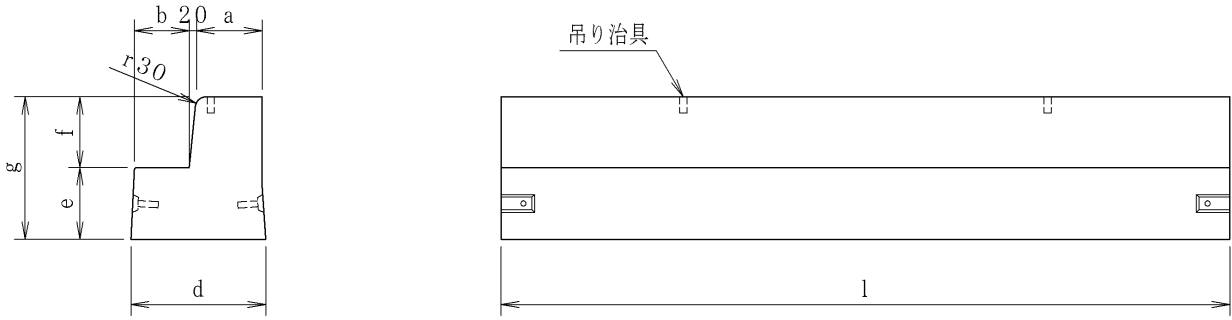

呼び名	寸法 (mm)										参考重量 (kg)
	a	b	c	d	e	f	g	h	i	l	
B	180	150	350	370	200	200	400	150	250	2000	506

【ベース付中央分離帯ブロック】

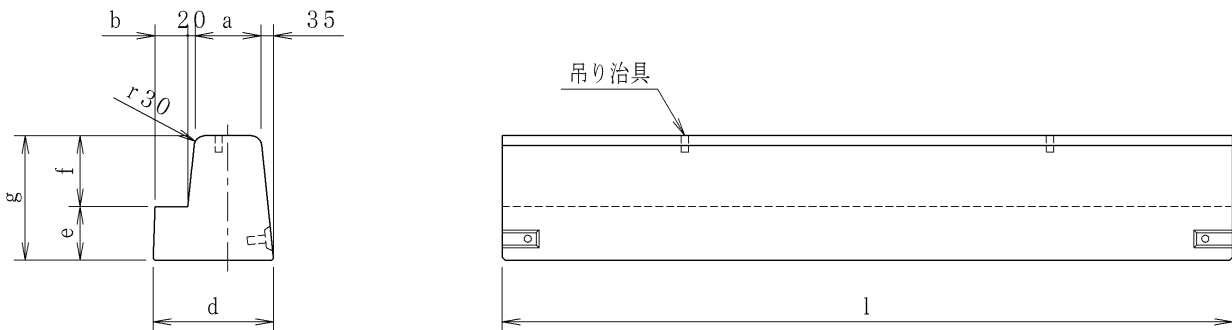

呼び名	寸法 (mm)							参考重量 (kg)
	a	b	d	e	f	g	l	
B	180	90	330	150	200	350	2000	422

【ベース無中央分離帯ブロック】

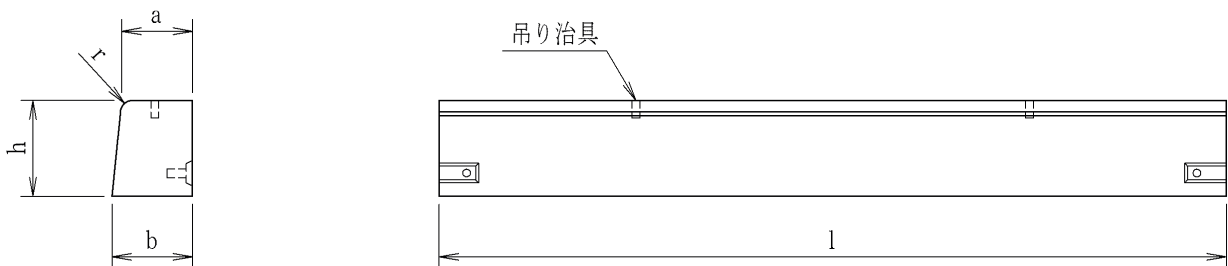

呼び名	寸法 (mm)				参考重量 (kg)
	a	b	h	l	
B	180	205	250	2000	226

【L型街渠】
[片面 標準]

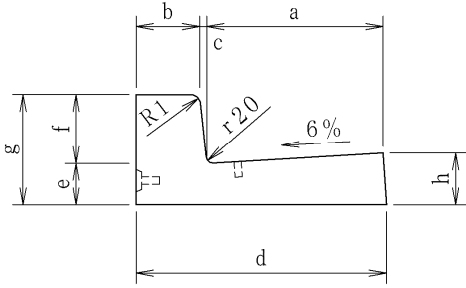

[片面 切り下げ]

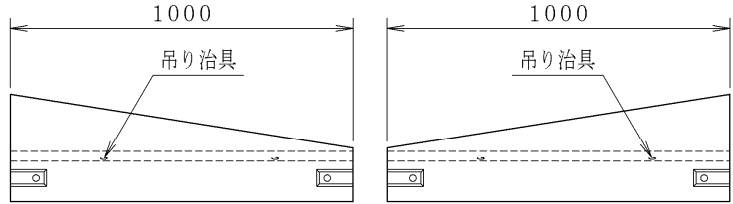
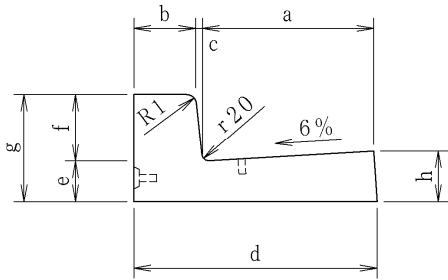

[片面 乗り入れ]

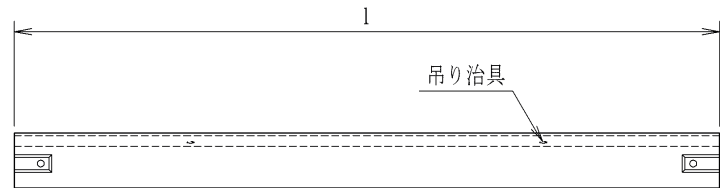
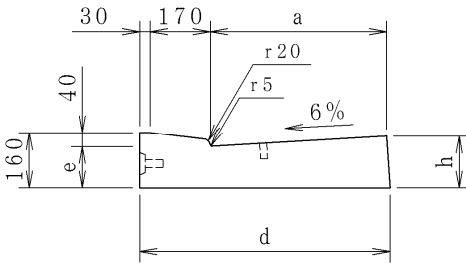

[片面 横断歩道乗り入れ 6%]

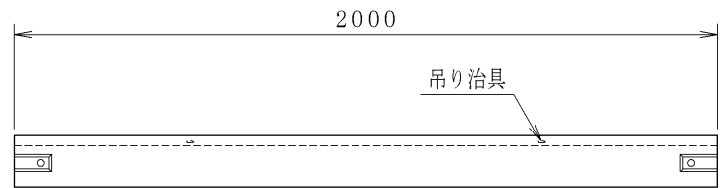
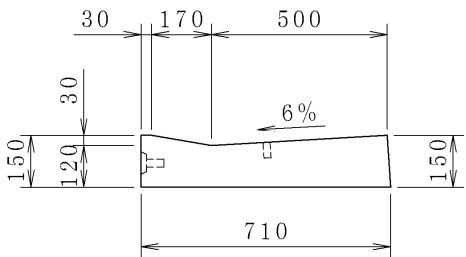

[片面 横断歩道乗り入れ 2%]

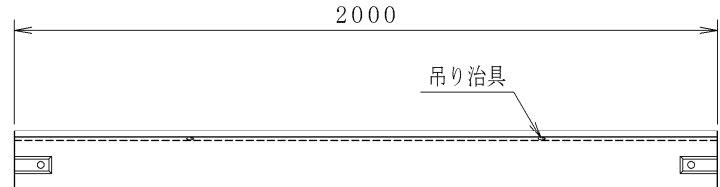
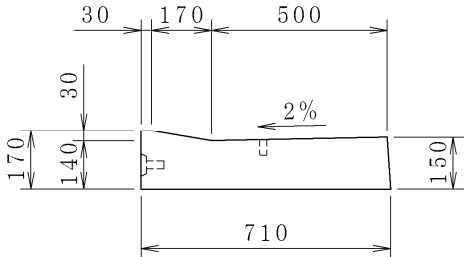

[両面 標準]

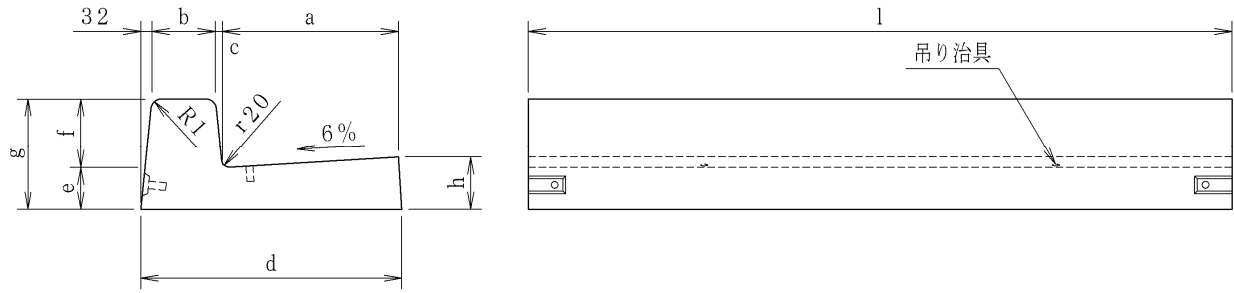

[両面 切り下げ]

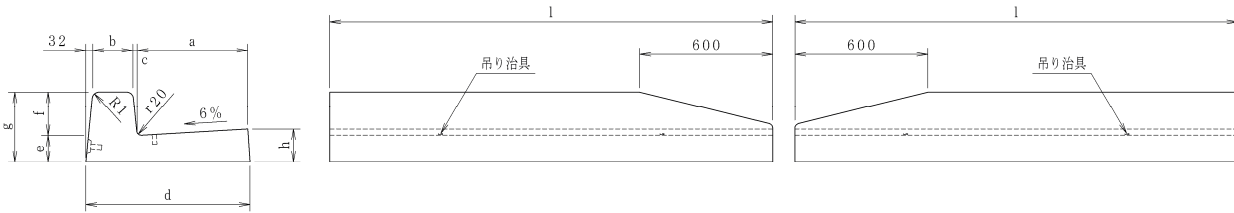

呼び名	寸法 (mm)										参考重量 (kg)
	a	b	c	d	e	f	g	h	R1	l	
B	500	180	20	756	120	200	320	150	30	2000	640
両面B	500	180	20	838	120	200	320	150	30	2000	702