

雑草防止製品

【ベース付歩車道境界ブロック】 [標準・水抜き]

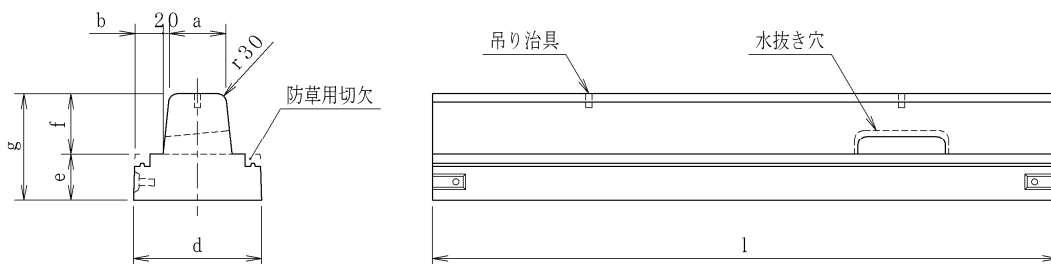

[切り下げ]

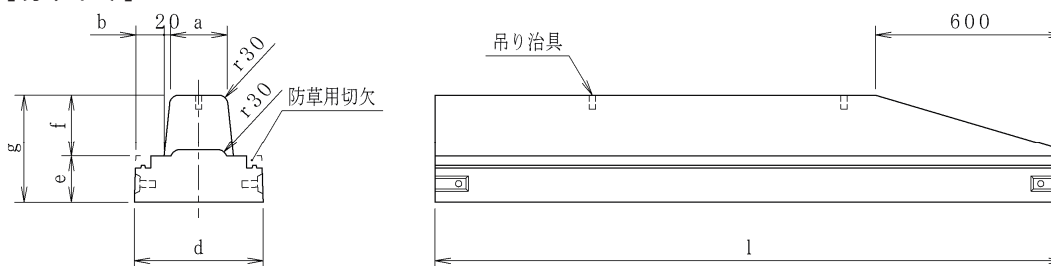

呼び名	寸法 (mm)							参考重量 (kg)
	a	b	d	e	f	g	l	
B	180	90	410	150	200	350	2000	445

【ベース付中央分離帯ブロック】

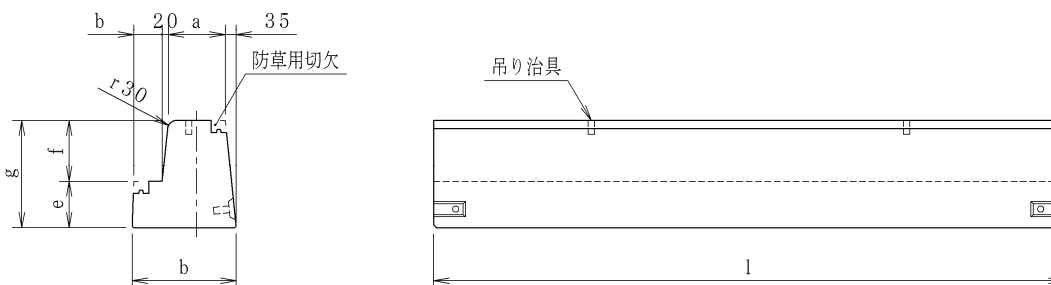

呼び名	寸法 (mm)							参考重量 (kg)
	a	b	d	e	f	g	l	
B	180	90	330	150	200	350	2000	388

【ベース無中央分離帯ブロック】

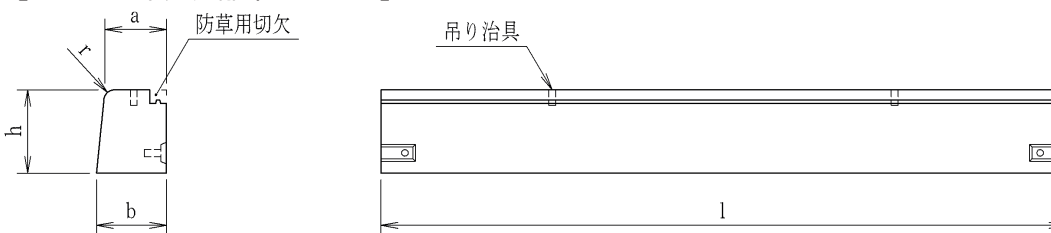

呼び名	寸法 (mm)				参考重量 (kg)
	a	b	h	l	
B	180	205	250	2000	226

【L型街渠】

[片面 標準]

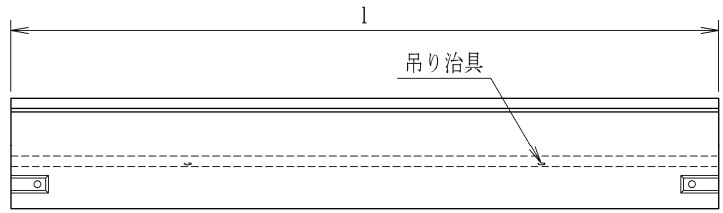
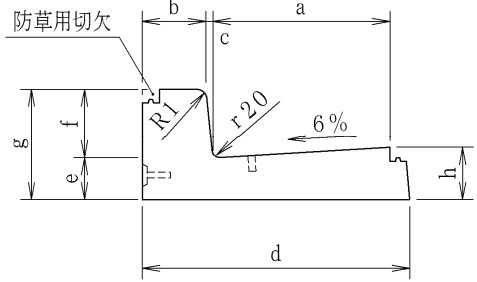

[片面 切り下げ]

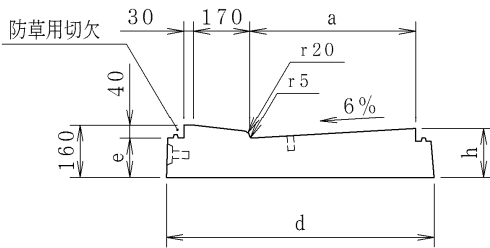
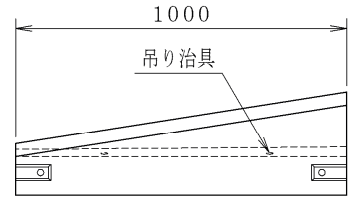
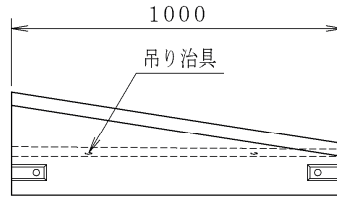
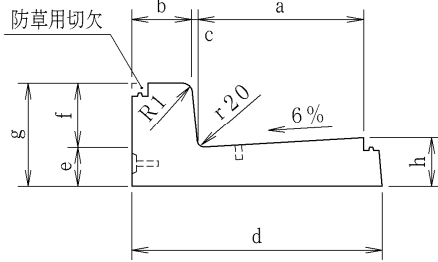

[片面 乗り入れ]

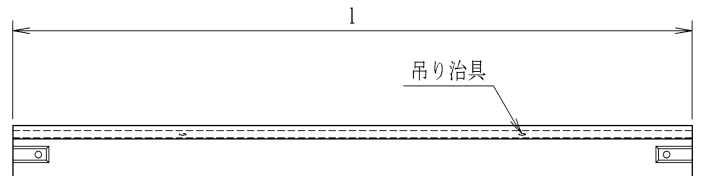
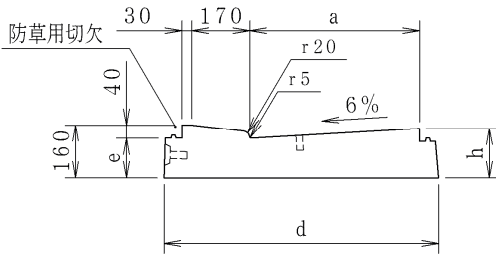

[片面 横断歩道乗り入れ6%]

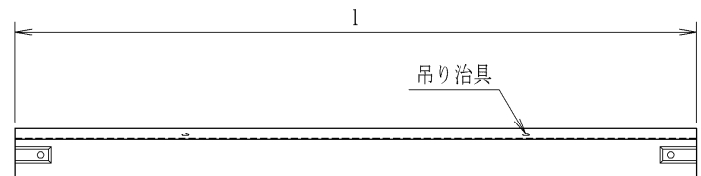
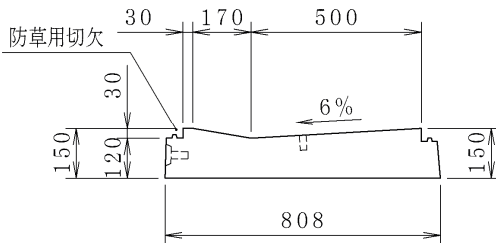

[片面 横断歩道乗り入れ2%]

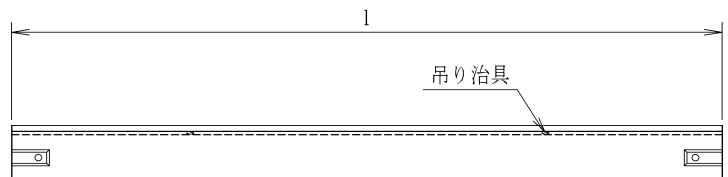
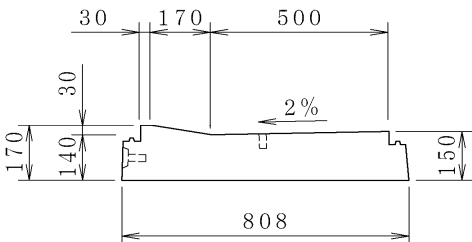

[両面 標準]

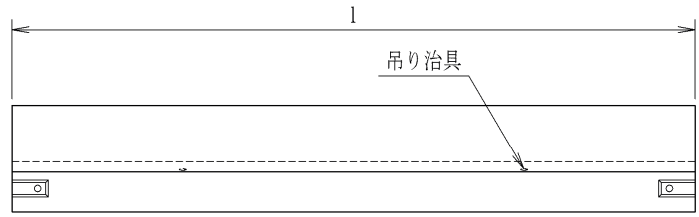
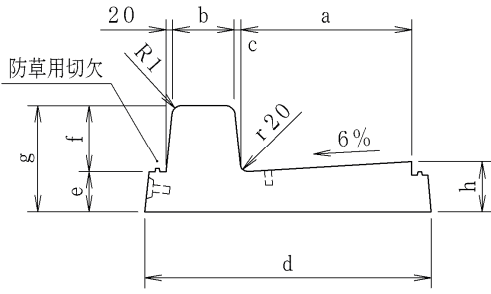

[両面 切り下げ]

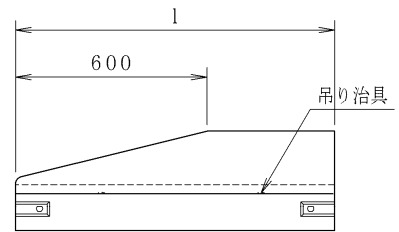
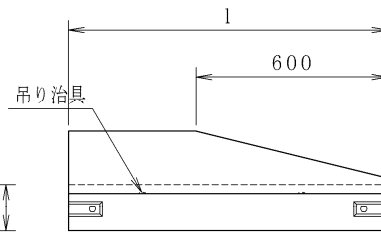
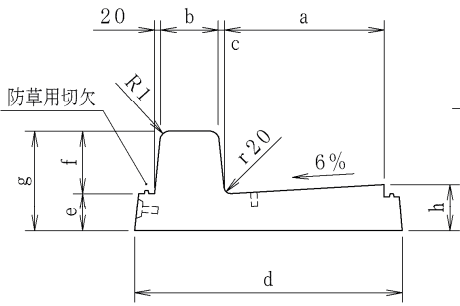

呼び名	寸法 (mm)										参考重量 (kg)
	a	b	c	d	e	f	g	h	R1	l	
B	500	180	20	756	120	200	320	150	30	2000	640
両面B	500	180	20	838	120	200	320	150	30	2000	702